

# S1004-ZD

## ZD hole pattern

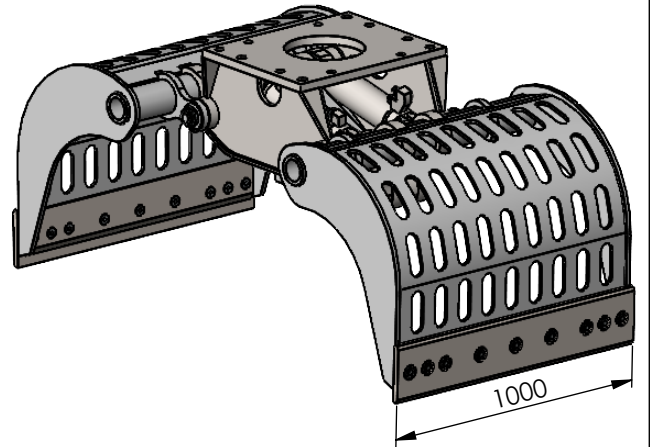

### Type:

Sloop- en sorteergrijper  
 Demolition and sorting grab  
 Abbruch- und Sortiergreifer  
 Grappin de Demolition et de triage

zijkant/side view/  
 Seitenansicht/vue de côté

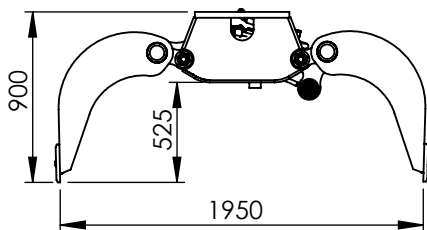

vooraanzicht/front view/  
 Vorderansicht/vue de face

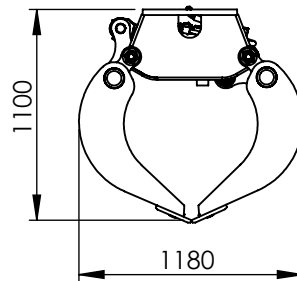

Gatenpatroon/hole pattern/  
 Bohrbild/motif de trous

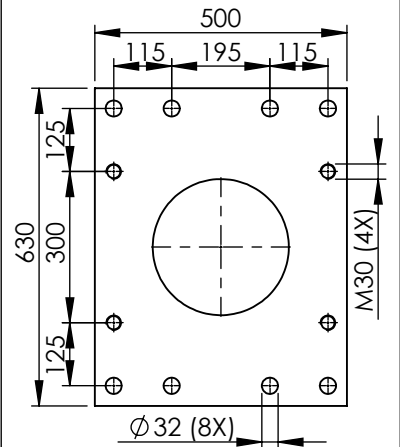

### Technical specifications

Nederlands 	English 	Deutsch 	Français 		
Klasse graafmachine	Class excavator	Machine klasse	Classe de excavatrice	ton	16-20
Gewicht	Weight	Gewicht	Poids	Kg	780
Werkdruk max.	Op. pressure max	Betät. druck max	Pression maximale	bar	350
Olieflow max	Oil flow max	Ölfluss max	Débit d'huile max	l/min	120
Inhoud	Content	Inhalt	Contenance	ltr.	700
Sluitkracht	Closing force	Schliesskraft	Force de fermeture	kN	46
Slangaansluiting knijpfunctie	Hose connect open/close	Schlauchanschluss kneifen	Raccord de tuyau fermeture	-	S20
Slangaansluiting draaifunctie	Hose connect turn function	Schlauchanschluss drehen	Raccord de tuyau rotation	-	