

# S8000-D

## HB7000 hole pattern

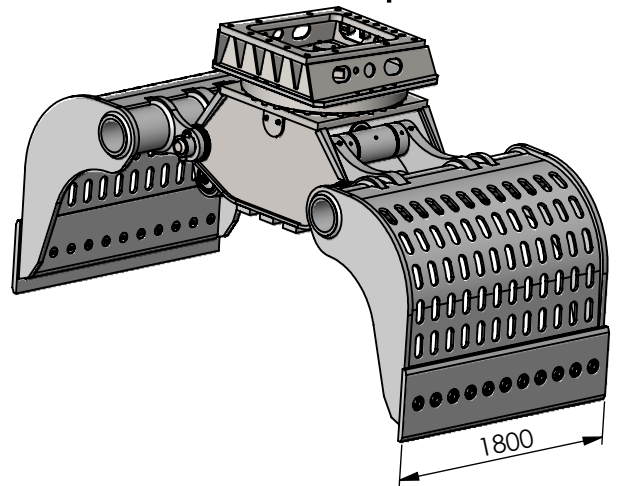

### Type:

Sloop- en sorteergrijper  
 Demolition and sorting grab  
 Abbruch- und Sortiergreifer  
 Grappin de Demolition et de triage

geopend/opened/  
 geöffnet/ouverte

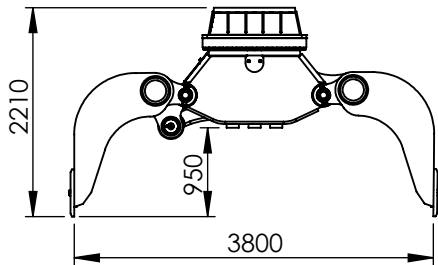

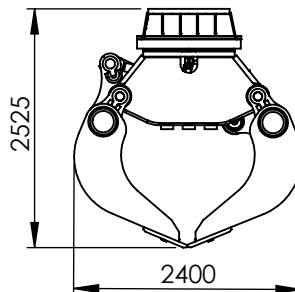

gesloten/closed/  
 geschlossen/fermé

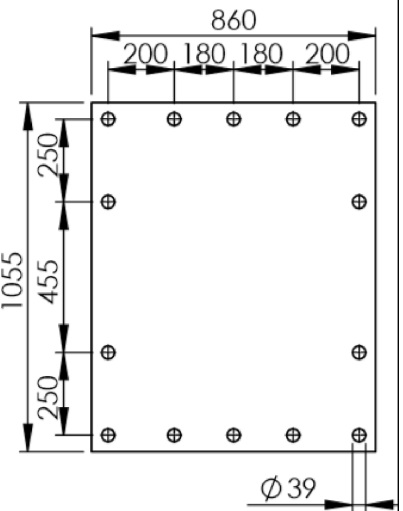

Gatenpatroon/hole pattern/  
 Bohrbild/motif de trous



### Technical specifications

Nederlands 	English 	Deutsch 	Français 		
Klasse graafmachine	Class excavator	Machine klasse	Classe de excavatrice	ton	70-120
Gewicht	Weight	Gewicht	Poids	Kg	7250
Werkdruk max.	Op. pressure max	Betät. druck max	Pression maximale	bar	350
Werkdruk rotatie max	Op. pressure rotation max	Betät. druck rotation max	Pression rotation max	bar	210
Werkdruk rotatie min	Op. pressure rotation min	Betät. druck rotation min	Pression rotation min	bar	190
Olieflow max	Oil flow max	Öfluss max	Débit d'huile max	l/min	320
Olieflow rotatie max	Oil flow rotation max	Öfluss rotation max	Débit d'huile rotation max	l/min	70
Inhoud	Content	Inhalt	Contenance	ltr.	3600
Sluitkracht	Closing force	Schliesskraft	Force de fermeture	kN	150
Slangaansluiting knijpfunctie	Hose connect open/close	Schlauchanschluss kneifen	Raccord de tuyau fermeture	-	SAE
Slangaansluiting draaifunctie	Hose connect turn function	Schlauchanschluss drehen	Raccord de tuyau rotation	-	S25