

S903-ZD

ZD hole pattern

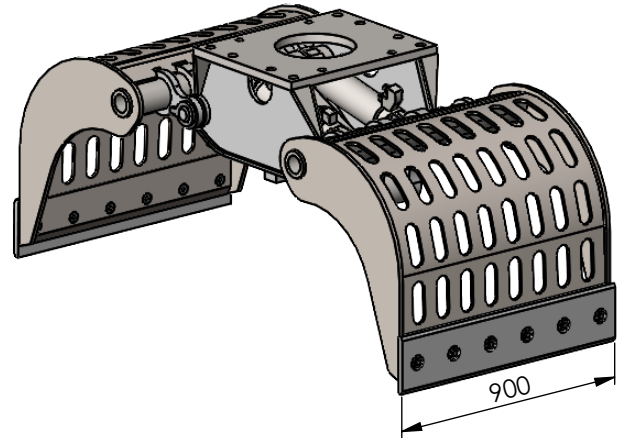

Type:

Sloop- en sorteergrijper
 Demolition and sorting grab
 Abbruch- und Sortiergreifer
 Grappin de Demolition et de triage

zijkant/side view/
 Seitenansicht/vue de côté

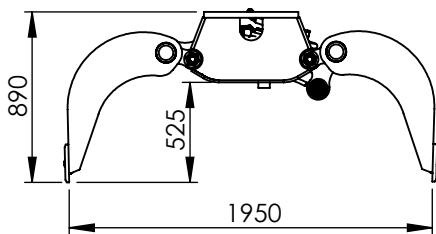

vooraanzicht/front view/
 Vorderansicht/vue de face

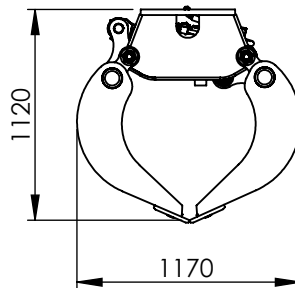

Gatenpatroon/hole pattern/
 Bohrbild/motif de trous

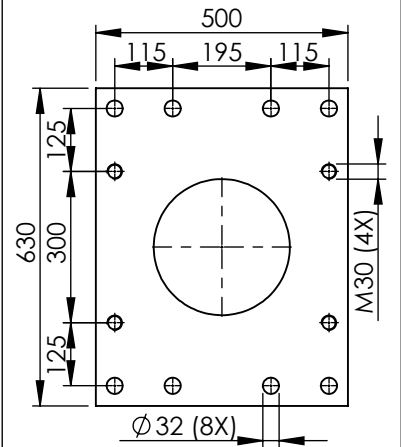

Technical specifications

Nederlands 	English 	Deutsch 	Français 		
Klasse graafmachine	Class excavator	Machine klasse	Classe de excavatrice	ton	13-20
Gewicht	Weight	Gewicht	Poids	Kg	785
Werkdruk max.	Op. pressure max	Betät. druck max	Pression maximale	bar	350
Olieflow max	Oil flow max	Ölfluss max	Débit d'huile max	l/min	120
Inhoud	Content	Inhalt	Contenance	ltr.	600
Sluitkracht	Closing force	Schliesskraft	Force de fermeture	kN	46
Slangaansluiting knijpfunctie	Hose connect open/close	Schlauchanschluss kneifen	Raccord de tuyau fermeture	-	S20
Slangaansluiting draaifunctie	Hose connect turn function	Schlauchanschluss drehen	Raccord de tuyau rotation	-	